



**B.PRO**  
CATERING SOLUTIONS

# B.PRO COOK

**Mobile cooking stations** COOK I-flex and COOK classic

# B.PRO COOK

**Discover FLEXILIGENCE.** Maximum flexibility with intelligent product features.

Fast, at any time, anywhere and always fresh – this new development for out-of-house catering offers attractive sales potentials. With the B.PRO COOK cooking stations you can keep up to date with the latest food service concepts and enhance your existing repertoire at the same time. Dishes are cooked directly in front of guests with an intelligent solution that allows you maximum flexibility.

## Flexiligent thinking

*The precise solution for your business idea:*

B.PRO COOK offers customised configurations in terms of size, performance categories and equipment.

## Flexiligent space

*Choose any place you like:* B.PRO COOK unites cooking technology and extractor hood in one system.

## Flexiligent timing

*Varying dishes from dawn to dusk and always up to date:* with B.PRO COOK, you can change the equipment configuration quickly and easily as required.

## Flexiligent design

*For a harmonious atmosphere:* B.PRO COOK offers you customised colour and material options to match your surroundings.

## Flexiligent organisation

*Makes work easier:* with clever ergonomics, a sensible surface layout and practical accessories, B.PRO COOK brings efficiency and structure to workflows.

## Flexiligent cleaning

*Effortless cleaning:* B.PRO COOK has impressively hygienic surfaces and easily accessible, dishwasher-safe parts that can be removed without tools.

## Flexiligent mobility

*Here today, there tomorrow:* just as well B.PRO COOK can follow you anywhere.



## B.PRO COOK in comparison: find out which model series best suits your concept.

	B.PRO COOK classic	B.PRO COOK I-flex
<b>Application recommendation</b>		
Output	Medium to high, can be used throughout the entire day, even at peak times	Low to medium, can be used throughout the entire day
Range of dishes	Same range of dishes all day or alternating throughout the week	Same or alternating range of dishes throughout the day
Mobility and use	Mobile cooking station, freely positionable, predominantly for use at a fixed location	Mobile cooking station, lightweight with compact dimensions, also suitable for catering use
<b>Cooking technology</b>		
Cooking area	Interchangeable high-performance table-top cooking units	Integrated induction hob
Number of hobs	For 2, 3 or 4 table-top cooking units BC classic 2.1, 3.1, 4.1	With 1, 2 or 3 induction hobs BC I-flex 1 (230 V), 2, 3
Cooking accessories	Wide selection: 13 different table-top cooking units of varying output and size for inserting and connecting to the unit socket outlets	Simple positioning of induction-compatible cooking inserts on the induction hob
<b>Design</b>		
Mains connection	400 V / 16 A to 63 A	230 V / 16 A and 400 V / 16 A
Weight	approx. 195–225 kg (without table-top cooking units)	approx. 130–150 kg
Installation options	<ul style="list-style-type: none"> <li>• mobile</li> <li>• stationary on adjustable feet</li> </ul>	<ul style="list-style-type: none"> <li>• mobile</li> <li>• mobile (out-of-house) as to-go version</li> <li>• stationary on adjustable feet</li> <li>• for fitting as built-in version</li> </ul>
Work surface	<p><u>Extraction bridge</u>: ample space for arranging and serving food</p> <p><u>Cooking area</u>: plenty of space to work to the left and right of the cooking zones</p>	<u>Extraction bridge</u> : ample space for arranging and serving food
Underframe	<ul style="list-style-type: none"> <li>• as storage space with a base bottom</li> <li>• for mobile underframe cooling table</li> <li>• for heated storage with B.PROTHERM</li> </ul>	<ul style="list-style-type: none"> <li>• for storing and stocking cooking inserts</li> <li>• and/or with drawer unit</li> </ul>
Material	Extraction bridge, work surfaces and underframe made entirely of stainless steel	Extraction bridge and work surfaces made of stainless steel, underframe made of galvanised, powder-coated thin sheet

## The ION TEC filter system filters blue smoke and increases the service life of activated charcoal.

- 1 Large particles such as grease are removed in the pre-filtering stages.
- 2 The particles which flow through the ioniser are charged positively by an electrostatic field. Highly reactive ozone is also generated from oxygen.
- 3 In the collector stage, the positively charged particles, especially aerosols, are attracted to the negatively charged plates and thus separated out.
- 4 In the oxidation process, ozone eliminates odours and blue smoke.
- 5 Particles attached to the activated charcoal which still need to be removed react with the residual ozone. This cleans the activated charcoal and significantly increases its service life.
- 6 Oxygen, carbon dioxide and water are released into the environment as end products.

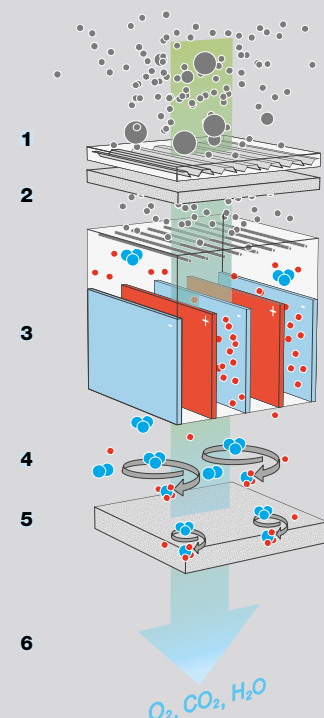

# COOK I-flex

**Compact and efficient:** The cooking station with infinite possibilities.

With its efficient, fully integrated induction technology with up to three hobs, B.PRO COOK I-flex guarantees maximum flexibility. A wide range of cooking inserts can be positioned with ease and quickly swapped.

This wide range of cooking equipment means that an equally varied array of food can be prepared to order, directly in front of customers, from dawn to dusk.

Thanks to its compact dimensions and integrated extractor hood, this cooking station can also be integrated in areas with space restrictions. In the mobile to-go version, B.PRO COOK I-flex is also ideal for catering and out-of-house assignments.





#### **B.PRO CONTROL**

Main switch, light and extraction level can be controlled with the buttons. The digital display indicates when filter replacement is required. Settings such as language, quick start and cleaning frequency can be configured here.



#### **Lighting as standard**

The standard LED light strip above the cooking zone illuminates the induction hobs optimally.



#### **A bridge to guests**

The ultra-slim extraction bridge ensures an unobstructed view of food preparation. It also includes plenty of space on top for keeping ingredients at hand and serving food. The optional railing provides added safety when items are placed on the bridge.



#### **Familiar operation**

Every induction hob consists of two cooking zones which can be controlled separately with rotary knobs. If required, both cooking zones can be switched on at the same time. The display shows the corresponding power setting.



#### **Securely positioned**

The rectangular griddles and deep griddles are kept firmly in the correct position on the cooking zone by the magnets under their handles, but can still be easily removed.



#### **Practical sneeze guard**

The standard sneeze guard made of toughened safety glass is easy to fold down for cleaning.



#### **Storage space as standard**

The underframe is divided into compartments and equipped with support brackets and a bottom base. It is perfect for storing cooking equipment for quick access.



#### **Drawers for extra supplies**

The optional drawer unit with two pull-outs provides space for GN containers with prepared ingredients. Additional eutectic plates can also be inserted to keep food cool if required.

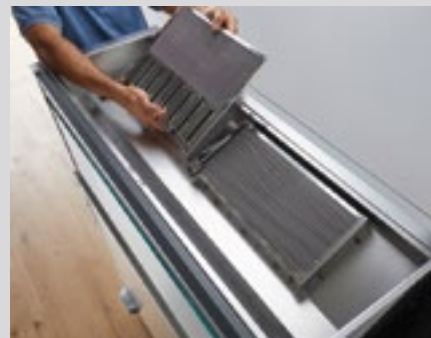

#### **Easy filter cleaning**

The filter cassettes, comprising a grease filter and wire mesh filter, can be removed without tools and can be cleaned in the dishwasher. Grease can be removed through a drain plug.

# COOK classic

**Powerful and spacious:** the cooking station for maximum performance.

B.PRO COOK classic is one of the sector's most popular time-tested front cooking solutions. The cooking stations for two, three or four high-performance table-top cooking units are ideally equipped for continuous daily service as well as for use at peak times.

With its modular design and wide selection of cooking technology, the range of dishes can be varied every day. New culinary trends are therefore easy to implement.

The integrated extraction bridge efficiently filters grease and odours, ensuring clean air in the dining area. Generously dimensioned work surfaces and storage space as well as coordinated accessories optimise workflows for quick and easy preparation.



**B.PRO COOK classic 4.1**

on operator side, with optional railing, mobile placement table and comprehensive accessories



Shown with accessories



**B.PRO CONTROL – clear and simple**

The electronic control with clear symbols makes operation extremely easy. The filter change indicator automatically reminds you to change or clean the filter.



**Spotlight on**

Integrated and flush LED spots illuminate the entire work surface optimally and put food in the right light.



**Generous storage surface**

Protected by a railing, the top of the extraction bridge can be used to present, garnish and serve food.



**More work space**

The areas to the left and right of the placement niche provide plenty of space to prepare, deposit and arrange food.



**More space: multi-frame**

The multi-frame offers space for depositing and storing items. Simply insert a GN container or add a glass shelf to create an additional work surface.



**Perfect protection**

The one-piece sneeze guard ensures optimum hygiene. It can be easily folded down for cleaning.



**Instant conversion**

The cooking unit placement shelf can be easily removed, e.g. to store a fixed-position floor unit.



**GN rails for any situation**

Everything that needs to be stored directly underneath the cooking units should be inserted here. Food or cooking utensils can be popped into GN 1/1 containers of varying depth.



**Filter changes – fast and easy**

The grease filter with integrated grease catch tray is easy to remove and clean in the dishwasher – without tools.

**Faster, hotter, better!**

## **B.PRO COOK classic is on top form.**

With reliable technology and an outstanding performance, B.PRO COOK classic table-top cooking units have already more than proven their value in practical use. They are characterised by their high-quality and functional design which guarantees simple handling, hygienic safety and maximum performance.

A total of thirteen different models provide everything a professional chef needs – from pasta cookers, induction woks and griddles through to deep fryers. Thanks to their compact dimensions and a depth of just 62 cm, the table-top cooking units also fit on standard worktops and can be flexibly combined as required.



### **Induction hobs and induction woks**

Depending on requirements, we offer a 1-zone induction hob, 2-zone induction hob, surface induction or induction wok – powerful, durable and extremely fast.



**Ceran® hob**  
with 2 independently adjustable cooking zones.

**Hot plate**  
with large heat-retaining area.

**Pasta cooker**  
for energy-saving cooking and steaming in pasta baskets or GN cooking inserts.

**Bain-marie**  
for keeping food hot and presenting dishes in GN containers.

**BC ME multi element**  
offers storage space for cooking utensils and ingredients, an additional work surface and help when arranging the food.







The front cooking trio for mouthwatering cooking shows: induction wok, ribbed griddle and pasta cooker.



**Deep fryer**  
with swivelling heating and unheated cold zone at the bottom of the basin.



**Deep griddle**  
can be used flexibly for braising, grilling or cooking.



**Griddles**  
ribbed or flat – the seamlessly welded-in griddle achieves a uniform temperature as desired. Excessive grease is collected in the large catch tray. With independently adjustable heating zones, the double-wide griddle offers efficiency at the touch of a button.

**B.PRO COOK classic:**  
**Innovative technology that everyone can taste.**

## B.PRO COOK I-flex 1

- Slim extraction bridge made of stainless steel for optimal visibility and usable area
- Integrated induction hob with two cooking zones
- B.PRO Control: electronic control of the extraction bridge and induction hob
- Sneeze guard made of toughened safety glass, pulled down to top surface on customer side, can be folded up
- LED lighting positioned over the cooking area
- Storage space with guide rail in the underframe, for example for storing cooking inserts
- Underframe powder-coated in traffic grey B RAL 7043



Illustration	Model	Dimensions (W x D x H) Weight	Connected load	Order No. (basic model)
--------------	-------	----------------------------------	----------------	----------------------------

### B.PRO COOK I-flex 1

<p>BC I-flex 1</p> 	<p><b>BC I-flex 1</b> with one integrated induction hob (2 cooking zones), positioned on the left on the operator side (can also be positioned on the right upon request)</p> <p><b>Mobile, castors 75 mm in diameter, 4 twin steering castors, 2 of which have brakes</b></p>	<p>Exterior dimensions: 925 x 678 x 1306 mm</p> <p>Height of underframe: 900 mm</p> <p>Usable area: 2x GN 1/1, of which 1x GN 1/1 heatable</p> <p>Empty weight: approx. 130 kg Max. load: 60 kg</p>	<p>220–240 V, 50/60 Hz, 1N PE, 3.4 kW</p> <p>230 V Schuko plug</p>	<p><b>575 025</b> <i>(384 400)</i></p>
--	--	---	--	--

**230 V**

### B.PRO COOK I-flex 1 to go

<p>BC I-flex1 to go</p> 	<p><b>BC I-flex 1 to go</b> with one integrated induction hob (2 cooking zones), positioned on the left on the operator side (can also be positioned on the right upon request)</p> <p><b>Mobile, stainless-steel castors 125 mm in diameter, 4 steering castors, 2 of which have brakes, corner guards, push handle</b></p>	<p>Exterior dimensions: 1020 x 746 x 1366 mm</p> <p>Height of underframe: 960 mm</p> <p>Usable area: 2x GN 1/1, of which 1x GN 1/1 heatable</p> <p>Empty weight: approx. 130 kg Max. load: 60 kg</p>	<p>220–240 V, 50/60 Hz, 1N PE, 3.4 kW</p> <p>230 V Schuko plug</p>	<p><b>575 064</b> <i>(384 400)</i></p>
---	--	--	--	--

**230 V**

### B.PRO COOK I-flex 1 built-in

<p>BC I-flex 1 built-in</p> 	<p><b>BC I-flex 1 built-in</b> with one integrated induction hob (2 cooking zones), positioned on the left on the operator side (can also be positioned on the right upon request)</p> <p><b>Stainless-steel adjustable feet, stainless-steel skirting panel on four sides, stainless-steel panel set on operator side</b></p>	<p>Exterior dimensions: 925 x 678 x 1306 mm</p> <p>Height of underframe: 900 mm</p> <p>Usable area: 2x GN 1/1, of which 1x GN 1/1 heatable</p> <p>Empty weight: approx. 130 kg Max. load: 60 kg</p>	<p>220–240 V, 50/60 Hz, 1N PE, 3.4 kW</p> <p>230 V Schuko plug</p>	<p><b>575 026</b> <i>(384 401)</i></p>
---	--	---	--	--

**230 V**

## B.PRO COOK I-flex 2

- Slim extraction bridge made of stainless steel for optimal visibility and usable area
- Integrated induction hobs with four cooking zones
- B.PRO Control: electronic control of the extraction bridge and induction hobs
- Sneeze guard made of toughened safety glass, pulled down to top surface on customer side, can be folded up
- LED lighting positioned over the cooking area
- Storage space with guide rail in the underframe, for example for storing cooking inserts
- Underframe powder-coated in traffic grey B RAL 7043



Illustration	Model	Dimensions (W x D x H) Weight	Connected load	Order No. (basic model)
--------------	-------	----------------------------------	----------------	----------------------------

### B.PRO COOK I-flex 2

	<b>BC I-flex 2</b> with two integrated induction hobs (4 cooking zones)  <b>Mobile, castors 75 mm in diameter,                      4 twin steering castors,                      2 of which have brakes</b>	Exterior dimensions: 925 x 678 x 1306 mm  Height of underframe: 900 mm  Usable area: max. 2x GN 1/1  Empty weight: approx. 130 kg Max. load: 60 kg	400 V, 50/60 Hz, 3N PE, 6.4 kW  16 A CEE plug	<b>575 013</b>  (384 396)
	<b>BC I-flex 2</b> as above, but with additional railing and ION TEC electrostatic filter			<b>575 014</b>  (384 396)

### B.PRO COOK I-flex 2 to go

	<b>BC I-flex 2 to go</b> with two integrated induction hobs (4 cooking zones)  <b>Mobile, stainless-steel castors                      125 mm in diameter,                      4 steering castors,                      2 of which have brakes,                      corner guards, push handle</b>	Exterior dimensions: 1020 x 746 x 1366 mm  Height of underframe: 960 mm  Usable area: max. 2x GN 1/1  Empty weight: approx. 130 kg Max. load: 60 kg	400 V, 50/60 Hz, 3N PE, 6.4 kW  16 A CEE plug	<b>575 015</b>  (384 396)
	<b>BC I-flex 2 to go</b> as above, but with additional railing and ION TEC electrostatic filter			<b>575 016</b>  (384 396)

### B.PRO COOK I-flex 2 built-in

	<b>BC I-flex 2 built-in</b> with two integrated induction hobs (4 cooking zones)  <b>Stainless-steel adjustable feet,                      stainless-steel skirting panel on                      four sides,                      stainless-steel panel set on                      operator side</b>	Exterior dimensions: 925 x 678 x 1306 mm  Height of underframe: 900 mm  Usable area: max. 2x GN 1/1  Empty weight: approx. 130 kg Max. load: 60 kg	400 V, 50/60 Hz, 3N PE, 6.4 kW  16 A CEE plug	<b>575 021</b>  (384 398)
	<b>BC I-flex 2 built-in</b> as above, but with additional railing and ION TEC electrostatic filter			<b>575 022</b>  (384 398)

The underlined models are available for delivery within 72 hours in commercially available volumes and standard packaging (subject to prior sale).

## B.PRO COOK I-flex 3

- Slim extraction bridge made of stainless steel for optimal visibility and usable area
- Integrated induction hobs with 6 cooking zones
- B.PRO Control: electronic control of the extraction bridge and induction hobs
- Sneeze guard made of toughened safety glass, pulled down to top surface on customer side, can be folded up
- LED lighting positioned over the cooking area
- Storage space with guide rail in the underframe, for example for storing cooking inserts
- Underframe powder-coated in traffic grey B RAL 7043



Illustration	Model	Dimensions (W x D x H) Weight	Connected load	Order No. (basic model)
--------------	-------	----------------------------------	----------------	----------------------------

### B.PRO COOK I-flex 3

	<b>BC I-flex 3</b> with three integrated induction hobs (6 cooking zones)  <b>Mobile, castors 75 mm in diameter,                      4 twin steering castors,                      2 of which have brakes</b>	Exterior dimensions: 1255 x 678 x 1306 mm  Height of underframe: 900 mm  Usable area: max. 3x GN 1/1  Empty weight: approx. 150 kg Max. load: 85 kg	400 V, 50/60 Hz, 3N PE, 9.4 kW  16 A CEE plug	<b>575 017</b>  (384 397)
	<b>BC I-flex 3</b> as above, but with additional railing and ION TEC electrostatic filter			

### B.PRO COOK I-flex 3 to go

	<b>BC I-flex 3 to go</b> with three integrated induction hobs (6 cooking zones)  <b>mobile, stainless-steel castors                      125 mm in diameter,                      4 steering castors,                      2 of which have brakes,                      corner guards, push handle</b>	Exterior dimensions: 1350 x 746 x 1366 mm  Height of underframe: 960 mm  Usable area: max. 3x GN 1/1  Empty weight: approx. 150 kg Max. load: 85 kg	400 V, 50/60 Hz, 3N PE, 9.4 kW  16 A CEE plug	<b>575 019</b>  (384 397)
	<b>BC I-flex 3 to go</b> as above, but with additional railing and ION TEC electrostatic filter			

### B.PRO COOK I-flex 3 built-in

	<b>BC I-flex 3 built-in</b> with three integrated induction hobs (6 cooking zones)  <b>Stainless-steel adjustable feet,                      stainless-steel skirting panel on                      four sides,                      stainless-steel panel set on                      operator side</b>	Exterior dimensions: 1255 x 678 x 1306 mm  Height of underframe: 900 mm  Usable area: max. 3x GN 1/1  Empty weight: approx. 150 kg Max. load: 85 kg	400 V, 50/60 Hz, 3N PE, 9.4 kW  16 A CEE plug	<b>575 023</b>  (384 399)
	<b>BC I-flex 3 built-in</b> as above, but with additional railing and ION TEC electrostatic filter			

## B.PRO COOK I-flex options

- \*Resopal panelling, shelves, plates and tray slides in the same decor/colour, faced with Resopal laminated sheet material "Colours" or "Woods"

Illustration	Designation	For models	
Body colour	<b>Body colour</b> in B.PRO colours (see page 28) instead of traffic grey B, RAL 7043	all BC I-flex	
Front faced with Resopal laminated sheet material 	<b>Front colour</b>	Powder-coated in B.PRO colours (see page 28) instead of traffic grey B, RAL 7043	all BC I-flex 1, 2, except built-in
		Faced with Resopal laminated sheet material	all BC I-flex 3, except built-in
			Faced with Resopal laminated sheet material
			all BC I-flex 3, except built-in
ION TEC 	<b>ION TEC electrostatic filtering</b> for improved filtering and reduction of odour particles and blue smoke; increases the service life of the charcoal filters	all BC I-flex	
	<b>Preparation for ION TEC electrostatic filtering</b> the BC I-flex is prepared to enable ION TEC filter retrofitting if required	all BC I-flex	
	<b>Available options: Hob on left or right on operator side</b>	BC I-flex 1	
Additional socket outlet 	<b>Additional socket outlet</b> , single-phase, positioned underneath the induction hob on the operator side (please note country variant)	BC I-flex 2	
Railing 	<b>Railing</b> made of stainless steel, round tube, on customer and short sides, height 50 mm	BC I-flex 1, 2	
		BC I-flex 3	
Drawer unit 	<b>Drawer unit</b> with 2 drawers positioned one above the other for Gastronorm containers, max. GN 1/1-150 or their subdivisions (with the help of cross- and lengthwise bars). Optionally available with two eutectic plates for passive cooling, which are inserted above each drawer using an integrated guide rail (see page 7)		
Tray slide, round tube 	<b>Tray slide</b>	Stainless-steel round tube, fold-down	BC I-flex 1, 2
			BC I-flex 3
		Stainless steel, smooth, fold-down	BC I-flex 1, 2
			BC I-flex 3
Plate slide, smooth 	<b>Plate slide</b>	Stainless steel, smooth, fold-down	BC I-flex 1, 2
			BC I-flex 3
		Resopal*, fold-down	BC I-flex 1, 2
			BC I-flex 3

The underlined models are available for delivery within 72 hours in commercially available volumes and standard packaging (subject to prior sale).

## Options for B.PRO COOK I-flex

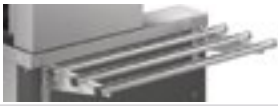

- \*Resopal panelling, shelves, plates and tray slides in the same decor/colour, faced with Resopal laminated sheet material "Colours" or "Woods"

Illustration	Designation		For models
	<b>Shelf</b> short side left/right	Stainless-steel round tube, fold-down	all BC I-flex
		Stainless steel, smooth, fold-down	
		Resopal*, fold-down	
not shown	<b>Module connection set</b> to permanently interconnect two BC I-flex or for combination with B.PRO BASIC LINE, including panelling to cover the gap between two modules		all BC I-flex
not shown	<b>Stainless-steel castors</b> , 4 steering castors, 2 of which have brakes, 125 mm in diameter		
not shown	<b>Stainless-steel adjustable feet</b>		
	<b>Stainless-steel skirting panels</b> , can only be ordered together with adjustable feet	Customer side/operator side	BC I-flex 1, 2
			BC I-flex 3
		Short side, left	all BC I-flex
		Short side, right	all BC I-flex





## Accessories for B.PRO COOK I-flex

Illustration	Designation	Order No. (basic model)
Griddle, flat 	<b>Griddle, 1/1-20, flat</b> with flat base, dimensions: 530 x 325 x 20 mm, weight: 4.9 kg	575 027  Made of cast aluminium with quadruple surface coating, incl. ceramic non-stick coating,  Thick base for optimal heat distribution and retention,  Stainless-steel handle on each short side and magnetic underpart to prevent slipping on the induction hob,
Griddle, ribbed 	<b>Griddle, 1/1-20, ribbed</b> with crosswise ribbing, dimensions: 530 x 325 x 20 mm, weight: 4.9 kg	575 028  Induction-compatible, heat-resistant up to 250 °C, dishwasher-safe
Deep griddle 	<b>Deep griddle, 1/1-55</b> with flat base, dimensions: 530 x 325 x 55 mm, weight: 4.7 kg	575 030
Wok 	<b>Flat-based wok</b> triple-layer material (stainless steel with aluminium core) up to the edge for rapid and even heat distribution and retention, with ergonomic handle, approx. 30 cm in diameter, induction-compatible, weight: 1.5 kg	575 032



## Accessories for B.PRO COOK I-flex

Illustration	Designation	Order No. (basic model)
	<b>Pasta cooker set</b> comprising: - stainless-steel frame, - GN 2/3-100 made of induction-compatible multi-layer material with two handles, - GN 1/3-65, - hanging frame for pasta baskets, - 4 baskets: approx. 1/6-100 with insulated handles	575 034
	<b>Frying pan</b> made of cast aluminium with quadruple surface coating, thick, non-warping base for optimal heat distribution and retention and energy-saving cooking, with ergonomic synthetic handle, ceramic non-stick coating, induction-compatible, heat-resistant up to 250 °C, dishwasher-safe, height of edge approx. 50 mm	20 cm dia. 575 035
		24 cm dia. 575 036
		26 cm dia. 575 037
		28 cm dia. 575 038
	<b>Multi-element 1/1</b> made of stainless steel, for preparing and arranging food or storing cooking utensils and ingredients, capacity: max. GN 1/1-65 or its subdivisions, dimensions: 544 x 330 x 93 mm	575 041
	<b>Multi-element 1/3</b> made of stainless steel, for storing cooking utensils and ingredients, capacity: max. GN 1/3-65 or its subdivisions, dimensions: 190 x 330 x 93 mm	575 042

### Cooking accessories











	<b>Spatula</b>	Made of silicone, with stainless-steel handle, heat-resistant up to 240 °C, dishwasher-safe, ideal for use with coated griddles and pans	575 067
	<b>Spoonula</b>		575 068
	<b>Barbecue tongs</b>		575 069
	<b>Pasta baskets</b> comprising: - hanging frame for pasta baskets - 4 baskets: approx. 1/6-100 with insulated handles		575 070
	<b>Ceran® cleaning scraper</b>		568 489

### Accessories

	<b>Synthetic cutting board,</b> with all-round juice groove, optimally adapted to the size of a hob, dimensions: 530 x 325 x 20 mm		575 057
	<b>Hygiene protection bridge</b> Quick and easy retrofitting of additional hygiene protection above the extraction bridge/bridge attachment with plate pass-through (approx. 18 cm), retrofit set consisting of stainless-steel attachment elements, toughened safety glass and mounting material	BC I-flex 1, 2	575 136
		BC I-flex 3	575 137

The underlined models are available for delivery within 72 hours in commercially available volumes and standard packaging (subject to prior sale).

## Accessories for B.PRO COOK I-flex

Illustration	Designation	Order No. <i>(basic model)</i>
Cutlery holder Shown with accessories 	<b><u>Cutlery holder</u></b> , stainless-steel frame for attaching to the body on the operator side, can be removed for cleaning, incl. GN 1/6-200	575 058
Knife holder Shown with accessories 	<b><u>Synthetic knife holder</u></b> – for cutlery holder, for mounting on GN 1/6	574 774
GN hanging frame Shown with accessories 	<b><u>GN hanging frame</u></b> , made of stainless steel for attaching to the short side of the body, fold-down, for holding 3x GN 1/6 or 1x GN 2/4	575 059
Dish towel holder Shown with accessories 	<b><u>Dish towel holder</u></b> , made of stainless steel for attaching to the short side of the body	575 060
Paper towel roll holder Shown with accessories 	<b><u>Paper towel roll holder</u></b> – for GN hanging frame and dish towel holder, made of stainless steel	575 062
Multi-frame Shown with accessories 	<b><u>Multi-frame</u></b> , made of stainless steel, for attaching to a stainless-steel or Resopal shelf on the short side, for holding one GN 1/3, can be removed for cleaning, incl. paper towel roll holder	575 061
Cabinet shelf 	<b><u>Cabinet shelf</u></b> made of glass – to insert into the multi-frame as an additional storage surface	573 978
Push handle 	<b><u>Push handle</u></b> for attaching to the short side of the body	575 063
not shown	<b><u>B.PRO COOK system instruction</u></b> Technical instruction (cleaning, filter change) for the B.PRO COOK I-flex installed ready for operation, date upon request.	999 125
Eutectic plate 	<b><u>Synthetic eutectic plate</u></b> (–3 °C), Gastronorm-compatible, dimensions: 530 x 325 x 30 mm, weight: 4.2 kg	568 136
	<b><u>Synthetic eutectic plate</u></b> (–12 °C), Gastronorm-compatible, dimensions: 530 x 325 x 30 mm, weight: 4.2 kg	573 332
Charcoal filter pads 	<b><u>Charcoal filter pads</u></b>	380 477



## B.PRO COOK classic

- For 2, 3 or 4 B.PRO COOK table-top units
- Narrow extraction bridge for ideal visibility
- Extremely effective filter system
- Electronic control with filter change indicator
- Large storage surface on the odour filter boxes
- Free usable space below the device placement shelf
- Castor model: solid synthetic castors, 75 mm dia, 8 steering castors, 2 of which have brakes



Shown with accessories

### B.PRO COOK classic

Illustration	Model	Dimensions W x D x H (mm)	Socket outlets/power/ connected load	Order no. (basic model)
	<b>BC classic 2.1</b> with removable unit placement shelf  max. load on unit placement shelf: about 150 kg  for 2 B.PRO COOK table-top units	<u>Exterior dimensions:</u> 1544 x 756 x 1362 mm <u>Height of underframe:</u> 900 mm <u>Device placement niche:</u> 806 x 648 x 300 mm <u>Usable space below placement shelf:</u> 830 x 648 x 575 mm	2 x 230 V Schuko socket outlets, 2 x 400 V CEE socket outlets (max. 10 kW)  16 A CEE plug  400 V, 50/60 Hz, 3N PE, 10.8 kW	<b>574 400</b>  (380 235)
	<b>BC classic 3.1</b> with removable unit placement shelf  max. load on unit placement shelf: about 150 kg  for 3 B.PRO COOK table-top units	<u>Exterior dimensions:</u> 1949 x 756 x 1362 mm <u>Height of underframe:</u> 900 mm <u>Device placement niche:</u> 1211 x 648 x 300 mm <u>Usable space below placement shelf:</u> 1235 x 648 x 575 mm	3 x 230 V Schuko socket outlets, 3 x 400 V CEE socket outlets (max. 20 kW)  32 A CEE plug  400 V, 50/60 Hz, 3N PE, 20.8 kW	<b>574 401</b>  (380 236)
	<b>BC classic 3.1 BHG</b> with removable unit placement shelf, featuring lighting, enclosed sneeze guard and railing  max. load on unit placement shelf: about 150 kg  for 3 B.PRO COOK table-top units	<u>Exterior dimensions:</u> 1949 x 756 x 1407 mm <u>Height of underframe:</u> 900 mm <u>Device placement niche:</u> 1211 x 648 x 300 mm <u>Usable space below placement shelf:</u> 1235 x 648 x 575 mm		<b>574 405</b>  (380 236)
	<b>BC classic 3.1 BHG-I</b> with removable unit placement shelf, featuring lighting, enclosed sneeze guard, railing and electronic ION TEC filtering  max. load on unit placement shelf: about 150 kg  for 3 B.PRO COOK table-top units			<b>574 406</b>  (380 236)

The underlined models are available for delivery within 72 hours in commercially available volumes and standard packaging (subject to prior sale).

## B.PRO COOK classic

- For 2, 3 or 4 B.PRO COOK table-top units
- Narrow extraction bridge for ideal visibility
- Extremely effective filter system
- Electronic control with filter change indicator
- Large storage surface on the odour filter boxes
- Free usable space below the device placement shelf
- Castor model: solid synthetic castors, 75 mm dia, 8 steering castors, 2 of which have brakes



Shown with accessories

### B.PRO COOK classic

Illustration	Model	Dimensions W x D x H (mm)	Socket outlets/power/ connected load	Order no. (basic model)
<p>BC classic 4.1</p>	<p><b>BC classic 4.1</b> with removable unit placement shelf and enclosed sneeze guard</p> <p>max. load on unit placement shelf: about 150 kg</p> <p>for 4 B.PRO COOK table-top units</p>	<p><u>Exterior dimensions:</u> 2354 x 756 x 1362 mm</p> <p><u>Height of underframe:</u> 900 mm</p> <p><u>Device placement niche:</u> 1616 x 648 x 300 mm</p> <p><u>Usable space below placement shelf:</u> 1640 x 648 x 575 mm</p>	<p>4 x 230 V Schuko socket outlets, 4 x 400 V CEE socket outlets (max. 20 kW)</p> <p>32 A CEE plug</p> <p>400 V, 50/60 Hz, 3N PE, 20.8 kW</p>	<p><b>574 402</b></p> <p><i>(380 237)</i></p>

### Options for BC classic





Illustration	Designation	For models
<p>ION TEC</p>	<p><b>ION TEC electrostatic filtering</b> for improved filtering and reduction of odour particles and blue smoke, increases the service life of the activated charcoal filters</p>	all BC classic
	<p><b>Preparation for ION TEC electrostatic filtering</b> The BC classic is prepared to enable ION TEC filter retrofitting if required.</p>	all BC classic

### Connected loads

Illustration	Designation	For models
not shown	<p><b>Connected load</b> 16 A CEE plug, 400 V, 50/60 Hz, 3N PE, 10.8 kW</p>	BC classic 3.1
	32 A CEE plug, 400 V, 50/60 Hz, 3N PE, 20.8 kW	BC classic 2.1
	63 A CEE plug, 400 V, 50/60 Hz, 3N PE, 40.8 kW	BC classic 4.1

# Options for B.PRO COOK classic

## Options for BC classic

Illustration	Designation	For models
Shown with storage shelf 	<b>Mobile placement table</b> for rolling in and out of the table-top cooking units in the B.PRO COOK classic in place of the unit placement shelf	BC classic 2.1 BC classic 3.1 BC classic 4.1
	<b>Storage shelf</b> to insert into the placement table as an additional storage surface	BC classic 2.1 BC classic 3.1 BC classic 4.1
not shown	<b>Additional socket outlets</b> 2 x 230 V Schuko socket outlets, in the usable space below the placement shelf, located both on the right and the left	all BC classic
	<b>Lighting</b> with LED spots (4 W each) located above the cooking units	5 spots, 20 W BC classic 2.1
		7 spots, 28 W BC classic 3.1
		9 spots, 36 W BC classic 4.1
	<b>Sneeze guard</b> made of safety glass (ESG) closed to customer side, can be folded up for cleaning	BC classic 2.1 BC classic 3.1 BC classic 4.1
	<b>Railing</b> , made of stainless-steel round tube, on the customer and short sides, high 50 mm	BC classic 2.1 BC classic 3.1 BC classic 4.1
	<b>Tray slide</b> Stainless-steel round tube, fold-down, on the customer side	Height 885 mm with castor diameter of 75 mm, matches the normal height for the BASIC LINE tray slide or Height 850 mm with castor diameter of 75 mm, matches the height of the MANHATTAN tray slide
	<b>Tray slide</b> Resopal, fold-down, customer side Multiplex panel faced with Resopal "Colours" or "Woods" laminated sheet	BC classic 2.1 BC classic 3.1 BC classic 4.1
not shown	<b>Base bottom</b> made of stainless steel, removable, maximum load: 80 kg	BC classic 2.1 BC classic 3.1 BC classic 4.1
	<b>Stainless steel castors</b> , 8 steering castors, 2 of which have brakes, <b>125 mm dia.</b> , total height is increased by 60 mm, height of the underframe is then 960 mm	all BC classic
	<b>Feet</b> made of stainless steel	all BC classic
	<b>Skirting panels</b> made of stainless steel, on customer side, can only be ordered to-gether with adjustable feet	BC classic 2.1 BC classic 3.1 BC classic 4.1



The underlined models are available for delivery within 72 hours in commercially available volumes and standard packaging (subject to prior sale).

# Accessories for B.PRO COOK classic

## Accessories

Illustration	Designation	For models	Order no. <i>(basic model)</i>
Shown with storage shelf 	<b>Mobile placement table</b> Used to roll table-top cooking units in and out of the B.PRO COOK classic	BC classic 2.1	574 309
		BC classic 3.1	574 310
		BC classic 4.1	574 311
	<b>Storage shelf</b> To insert into the placement table as additional storage surface	BC classic 2.1	574 379
		BC classic 3.1	574 380
		BC classic 4.1	574 381
Shown with accessories 	<b>Multi-frame with bracket</b> Made of stainless steel to fasten to the odour filter boxes on the operator side, to hold a GN 1/3 or its subdivisions, including a bracket to hold a roll of paper towels	All BC classic	573 977
	<b>Cabinet shelf</b> made of glass To insert into the multi-frame as an additional storage surface	Multi-frame	573 978
	<b>Transport dolly BC ROL 6x4</b> To roll a B.PROTHERM 420 into free usable space, synthetic castors, 4 steering castors, 2 of which have brakes, 50 mm in diameter, load capacity: about 100 kg	All BC classic	573 570
	<b>BPT 420 KBRUH</b> B.PROTHERM synthetic food transport containers, convection-heated, <u>with digital temperature control</u> to adjust the temperature in the interior to precise degree between +40 °C and +85 °C, with hinged door, capacity: 2 x GN 1/1-150 or their subdivisions, 11 pairs of support ledges, gap 31 mm	Colour for fastening components: grey blue red green yellow	573 516 574 575 574 576 574 577 574 578 (380 904)
Shown with accessories 	<b>Drawer rail set</b> Consisting of two rails to hold a GN 1/1, to be mounted on the underside of the unit placement shelf	All BC classic	573 979
not shown	<b>B.PRO COOK system instruction</b> Technical instruction (cleaning, filter change) for the B.PRO COOK classic installed ready for operation, handling the B.PRO COOK table-top units. Date upon request.	All BC classic	999 125





## Consumables/spare parts (sale via B.PRO Service)

	<b>Fleece filter mats</b> 1 packing unit = 25 units		107 213
	<b>Charcoal filter pads</b> 1 set (1 set = 2 units)		134 046

## Panelling for B.PRO COOK classic

- As a retrofit
- Can also be incorporated directly into the BC classic
- In B.PRO colours (see page 28)

### Panelling for BC classic (also as a retrofit)

Illustration	Designation	For models	Order no.
	<b>3-sided panelling</b>  <b>Powder-coated</b> on customer and short sides, The customer and short sides can each feature different colours	BC classic 2.1	<b>380 086</b>
		BC classic 3.1	<b>380 087</b>
		BC classic 4.1	<b>380 088</b>
	Faced with <b>Resopal laminated sheet</b> (Resopal colours/decors on customer side: Colours, Woods), short sides powder-coated	BC classic 2.1	<b>380 089</b>
		BC classic 3.1	<b>380 090</b>
		BC classic 4.1	<b>380 091</b>
	Decors: Colours, Woods	BC classic 2.1	<b>380 096</b>
		BC classic 3.1	<b>380 097</b>
		BC classic 4.1	<b>380 098</b>
	<b>Column panelling</b> Powder-coated, set consisting of left- and right-hand side, including mounting components on the exhaust ducts	All BC classic	<b>380 794</b>

## Accessories for B.PRO COOK classic

- Active convection cooling, can be adjusted down to the degree between  $-2\text{ }^{\circ}\text{C}$  and  $+8\text{ }^{\circ}\text{C}$  (at ambient temperature of  $43\text{ }^{\circ}\text{C}$  and 40% relative humidity)
- Ready to plug in with socket outlet for non-heating unit (connection of country-specific plug possible)
- Evaporator housing made of stainless steel, finned evaporator complete with synthetic-coated tubes and fins, which makes it corrosion-resistant and odour-free
- Refrigerant R290, CFC-free
- Castor model: 50 mm dia., 4 steering castors, 2 of which have brakes



### Underframe cooling table for BC classic 3.1, BC classic 4.1

Illustration	Model	Dimensions W x D x H (mm)	Rating/ connected load	Order no.
	<p><b>BC UCT 2D</b> <b>underframe cooling table with 2 hinged doors,</b> 2 double-walled hinged doors, thermally insulated with foam, can be swivelled with magnetic sealing frames, two pairs height-adjustable support rails per compartment for inserting Gastronorm container GN 1/1</p>	1192 x 650 x 567 mm	220–240 V 1N PE 50–60 Hz 0.32 kW	<b>575 219</b>
	<p><b>BC UCT 4E</b> <b>underframe cooling table with 2 full extension drawers</b> 2 full extension drawers per side, thermally insulated with foam, magnetic sealing frames, for GN 1/1 Gastronorm containers or their subdivision with the help of cross- and lengthwise bars, maximum depth of GN is 100 mm</p>	1192 x 650 x 567 mm	220–240 V 1N PE 50–60 Hz 0.32 kW	<b>575 220</b>

## B.PRO COOK table-top units



- Smooth Ceran surface
- Microprocessor-controlled high-performance induction generator made by E.G.O.
- Continuous power adjustment with rotary knob, indicator light to display operating mode and error code in the event of faults
- High efficiency
- Air filter on unit base
- Height-adjustable rotating feet, mains connection cable (1.5 m)



### Induction hob

Illustration	Model	Dimensions L x W x H (mm)	Rating/ connected load	Order no.
	<b>BC IH 3500</b> <b>Induction hob,</b> automatic pot detection from 120 mm dia.	Exterior dimensions: 620 x 400 x 240 mm Usable area: 564 x 339 mm Cooking zone: 220 x 220 mm Weight: 19 kg	220–240 V 1N PE 16 A 50–60 Hz 3.5 kW	<b>574 197</b>
	<b>BC IH 5000</b> <b>Induction hob,</b> automatic pot detection from 120 mm dia.	Exterior dimensions: 620 x 400 x 240 mm Usable area: 564 x 339 mm Cooking zone: 220 x 220 mm Weight: 19 kg	400 V 3N PE 16 A 50–60 Hz 5.0 kW	<b>574 198</b>
	<b>BC IH 2Z 5000</b> <b>2-zone</b> <b>induction hob,</b> 2 separately adjustable heating zones (2 coils, each with 220 mm dia.), automatic pot detection from 120 mm dia.	Exterior dimensions: 620 x 400 x 240 mm Usable area: 564 x 339 mm 2 cooking zones, each with Ø 220 mm Weight: 27 kg	400 V 3N PE 16 A 50–60 Hz 2 x 2.5 kW (5.0 kW)	<b>574 199</b>
	<b>BC SIH 5000</b> <b>Surface induction hob,</b> 1 rectangular cooking zone (1 heating zone 447 x 220 mm), automatic pot detection from 120 mm dia.	Exterior dimensions: 620 x 400 x 240 mm Usable area: 564 x 339 mm Cooking zone: 447 x 220 mm Weight: 27 kg	400 V 3N PE 16 A 50–60 Hz 5.0 kW (2 x 2.5 kW)	<b>574 200</b>

### Induction wok

	<b>BC IW 3500</b> <b>Induction wok</b>	Exterior dimensions: 620 x 400 x 240 mm Cuvette: 300 mm dia. Weight: 18 kg	220–240 V 1N PE 16 A 50–60 Hz 3.5 kW	<b>574 201</b>
	<b>BC IW 5000</b> <b>Induction wok</b>	Exterior dimensions: 620 x 400 x 240 mm Cuvette: 300 mm dia. Weight: 18 kg	400 V 3N PE 16 A 50–60 Hz 5.0 kW	<b>574 202</b>

The underlined models are available for delivery within 72 hours in commercially available volumes and standard packaging (subject to prior sale).

## B.PRO COOK table-top units

- All-round seamlessly welded, 15 mm-thick griddle with rounded corners for optimal hygiene and even, full-surface heat distribution through tubular heating elements
- Unheated resting zone (70 mm) on operator side
- Continuous temperature adjustment with rotary knobs
- Indicator lights to display operating mode and heating phase
- Height-adjustable rotating feet, mains connection cable (1.5 m)



### Griddle

Illustration	Model	Dimensions L x W x H (mm)	Rating/ connected load	Order no.
	<b>BC GF 3500</b> <b>Griddle, flat</b> incl. grease drain plug, extremely powerful from +80 to +250 °C	Exterior dimensions: 620 x 400 x 240 mm Usable area: 506 x 304 mm of which 435 x 304 mm is heated Weight: 34 kg	220–240 V 1N PE 16 A 50–60 Hz 3.5 kW	<b>574 203</b>
	<b>BC GF 4200</b> <b>Griddle, flat</b> incl. grease drain plug, extremely powerful from +80 to +250 °C	Exterior dimensions: 620 x 400 x 240 mm Usable area: 506 x 304 mm of which 435 x 304 mm is heated Weight: 34 kg	400 V 3N PE 16 A 50–60 Hz 4.2 kW	<b>574 204</b>
	<b>BC GF 8400</b> <b>Griddle, flat</b> incl. grease drain plug, extremely powerful from +80 to +250 °C, 2 separately adjustable heating zones	Exterior dimensions: 620 x 800 x 240 mm Usable area: 506 x 704 mm of which 435 x 704 mm is heated Weight: 69 kg	400 V 3N PE 16 A 50–60 Hz 8.4 kW (2 x 4.2 kW per heating zone)	<b>574 205</b>
	<b>BC GR 3500</b> <b>Griddle, ribbed</b> incl. grease drain plug, extremely powerful from +80 to +250 °C	Exterior dimensions: 620 x 400 x 240 mm Usable area: 506 x 304 mm of which 435 x 304 mm is heated Weight: 31 kg	220–240 V 1N PE 16 A 50–60 Hz 3.5 kW	<b>574 206</b>
	<b>BC GR 4200</b> <b>Griddle, ribbed</b> incl. grease drain plug, extremely powerful from +80 to +250 °C	Exterior dimensions: 620 x 400 x 240 mm Usable area: 506 x 304 mm of which 435 x 304 mm is heated Weight: 31 kg	400 V 3N PE 16 A 50–60 Hz 4.2 kW	<b>574 207</b>

### Deep griddle

	<b>BC DG 4200</b> <b>Deep griddle</b> incl. grease drain plug, extremely powerful from +80 to +250 °C	Exterior dimensions: 620 x 400 x 240 mm Usable area: 506 x 304 mm Capacity: 7 litres Basin depth: 65 mm Weight: 33 kg	400 V 3N PE 16 A 50–60 Hz 4.2 kW	<b>574 208</b>
---	---	--	--	----------------



## B.PRO COOK table-top units

- Continuous temperature adjustment with rotary knobs
- Height-adjustable rotating feet
- Mains connection cable (1.5 m)



### Ceran® hob

Illustration	Model	Dimensions L x W x H (mm)	Rating/ connected load	Order no.
 <p>BC CH 4300</p>	<p><b>BC CH 4300</b> Ceran® hob, indicator lights to display operating mode</p>	<p>Exterior dimensions: 620 x 400 x 240 mm Usable area: 564 x 339 mm Cooking zone: 170 mm dia. and 230 mm dia. Weight: 12 kg</p>	<p>400 V 3N PE 16 A 50–60 Hz 4.3 kW</p>	<p>574 209</p>

### Pasta cooker



 <p>BC PC 4800 (shown with accessories)</p>	<p><b>BC PC 4800</b> Pasta cooker, seamlessly deep-drawn basin, for the insertion of GN contain- ers or pasta baskets up to 150 mm in depth, indicator light to display operating mode and heating phase</p>	<p>Exterior dimensions: 620 x 400 x 240 mm Usable area: 509 x 304 mm Capacity: 20 litres Weight: 14 kg</p>	<p>400 V 3N PE 16 A 50–60 Hz 4.8 kW</p>	<p>574 210</p>
	<p><b>Pasta basket set</b> Baskets with insulated handles and insertion frame</p>	<p>6 baskets: approx. GN 1/6-100</p>		<p>574 254</p>
	<p><b>Pasta basket set</b> Baskets with insulated handles and insertion frame</p>	<p>2 baskets: approx. GN 1/3-100 and 2 baskets: approx. GN 1/6-100</p>		<p>574 255</p>
	<p><b>Gastronorm cooking insert</b> <b>G-KEN G 1/1-95</b> perforated, with folding handles</p>			<p>550 971</p>
	<p><b>Lid with handle, GD 1/1</b> for covering</p>			<p>550 658</p>

## B.PRO COOK table-top units

- Continuous temperature adjustment with rotary knobs
- Indicator lights to display operating mode and heating phase
- Height-adjustable rotating feet, mains connection cable (1.5 m)



### Deep fryer

Illustration	Model	Dimensions L x W x H (mm)	Rating/ connected load	Order no.
 <p>BC DF 5000 (shown with accessories)</p>	<p><b>BC DF 5000</b> <b>Deep fryer</b> Seamlessly deep-drawn basin, cold zone at the bottom of the basin, swivelling, interior heating elements, incl. lid to cover deep-frying basin</p>	<p>Exterior dimensions: 620 x 400 x 240 mm Usable area: 346 x 238 mm Capacity: min. 5 litres, max. 6.5 litres Weight: 16 kg</p>	<p>400 V 3N PE 16 A 50–60 Hz 5.0 kW</p>	<p><b>574 211</b></p>
	<p><b>Deep-frying basket set</b> (2 pcs.) with insulated handles</p>	<p>260 x 95 x 110 mm each</p>		<p><b>574 258</b></p>
	<p><b>Deep-frying basket</b> with insulated handle</p>	<p>260 x 220 x 110 mm</p>		<p><b>574 259</b></p>

### Bain-marie

 <p>BC BM 700</p>	<p><b>BC BM 700</b> <b>Bain-marie</b> Seamlessly deep-drawn basin, suitable for stainless-steel GN containers and GN lids, can be heated from +45 to +95 °C</p>	<p>Exterior dimensions: 620 x 400 x 240 mm Usable area: 509 x 304 mm Capacity: max. 1 x GN 1/1-150 Weight: 15.5 kg</p>	<p>220–240 V 1N PE 16 A 50–60 Hz 0.7 kW</p>	<p><b>574 212</b></p>
--	---	--	---	-----------------------

### Hot plate

 <p>BC HP 700</p>	<p><b>BC HP 700</b> <b>Hot plate</b> Hot plate with thermally separated heating-retaining area, silicone-sealed heat-retaining surface made of stainless steel, temperature range: +55 to +120 °C</p>	<p>Exterior dimensions: 620 x 400 x 240 mm Usable area: 565 x 340 mm Weight: 18 kg</p>	<p>220–240 V 1N PE 16 A 50–60 Hz 0.7 kW</p>	<p><b>574 213</b></p>
--	---	--	---	-----------------------

## B.PRO COOK table-top units

- Height-adjustable rotating feet



### Multi-element

Illustration	Model	Dimensions L x W x H (mm)	Rating/ connected load	Order no.
	<b>BC ME</b> <b>Multi-element</b>	Exterior dimensions: 620 x 400 x 240 mm Capacity: Top: max. GN 1/1-150 (depending on depth of container located below) Below: max. GN 1/1-100 (in this case, top: max. GN 1/1-65) Weight: 7 kg		<b>573 458</b>

## Accessories for B.PRO COOK table-top units

### Accessories

Illustration	Designation	For model	Order no.
	<b>Ceran® cleaning scraper</b>	For BC IH, induction hob, BC CH Ceran® hob	<b>568 489</b>
	<b>Round-bottom wok</b> made of stainless steel, 360 mm dia., max. capacity 5.5 litres, weight 1.2 kg	For BC IW induction wok	<b>573 513</b>
	<b>Pasta basket set</b> Baskets with insulated handles and insertion frame	6 baskets: approx. GN 1/6-100	For BC PC pasta cooker <b>574 254</b>
		2 baskets: approx. GN 1/3-100 and 2 baskets: approx. GN 1/6-100	<b>574 255</b>
	<b>G-KEN G 1/1-95 Gastronorm cooking insert</b> perforated, with folding handles	For BC PC pasta cooker	<b>550 971</b>
	<b>Lid with handle, GD 1/1</b> for covering	For BC PC pasta cooker	<b>550 658</b>
	<b>Grill cleaning scraper, flat</b>	For BC DG deep griddle, for BC GF griddle, flat	<b>573 252</b>
not shown	<b>Grill cleaning scraper, ribbed</b>	For BC GR griddle, ribbed	<b>574 306</b>
	<b>Splash guard</b>	For BC GF and BC GR griddles (except BC GF 8400)	<b>574 256</b>
		For BC GF 8400 griddle	<b>574 257</b>
not shown	<b>B.PRO COOK anti-stick care</b> 500 ml, protects and cares for the grill surface and improves anti-stick performance	For griddles and deep griddles	<b>574 302</b>
	<b>Deep-frying basket set</b> (2 pcs.) with insulated handles 260 x 95 x 110 mm each (L x W x H)	For BC DF deep fryer	<b>574 258</b>
	<b>Deep-frying basket</b> with insulated handles 260 x 220 x 110 mm each (L x W x H)	For BC DF deep fryer	<b>574 259</b>
	<b>Clamping bar</b> made of stainless steel to cover the gap between two B.PRO COOK table-top units	For all models	<b>574 298</b>

The underlined models are available for delivery within 72 hours in commercially available volumes and standard packaging (subject to prior sale).

## B.PRO colours

### NEUTRAL COLOURS



Graphite black



Traffic grey B



Stone grey

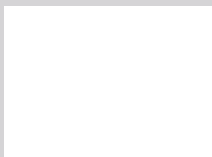

Signal white

### LIVING COLOURS



Broom yellow



Merlot red



Petrol green



Sea blue

### FRESH COLOURS



Candy red



Neomint

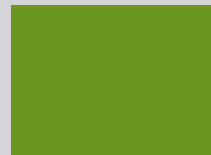

Apple green

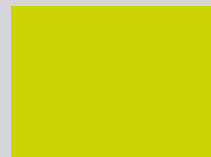

Lime

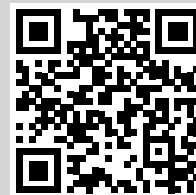

You will find more info on Resopal colours  
and decors at  
[www.bpro-solutions.com/en/resopal](http://www.bpro-solutions.com/en/resopal)

B.PRO GmbH  
B.PRO Catering Solutions  
P.O. Box 13 10  
75033 Oberderdingen  
Germany  
Phone +49 7045 44-81900  
[catering.export@bpro-solutions.com](mailto:catering.export@bpro-solutions.com)  
[www.bpro-solutions.com](http://www.bpro-solutions.com)

**B.PRO**  
CATERING SOLUTIONS