



B.PRO
CATERING SOLUTIONS

SENIOR CITIZEN CATERING

Commercial catering in elderly and care homes: delicious food served well.

TASTY MEALS EVERY DAY

Effective and appealing commercial catering for senior citizens brings pleasure and enjoyment to mealtimes. At the same time it is important that the food on offer meets specific nutritional requirements.

This is achieved by using high-quality, fresh ingredients – also when the elderly require smaller portions. Daily preparation in care facilities is equally important. With Cook & Serve, the wide selection of dishes can be controlled with full flexibility. Food is freshly prepared and quantities can be adapted to requirements.

Habits and background are of particular importance when it comes to culinary preferences, especially as we age. Fresh preparation makes it easier to cater to individual wishes.

Bringing quality to the table.

Regardless of whether food is served in a large dining hall, common room or the residents' own rooms, soup should be hot and salad crisp and appetising.

What sounds simple is often one of the major challenges in the catering industry. Cost-effectiveness and compliance with HACCP guidelines must be ensured, but ultimately everything centres on the diners, as mealtimes are often one of the highlights of their day.

Clever products and solutions by B.PRO facilitate the workflow – for perfect food distribution.



Ladling system

First-class solutions for Cook & Serve: our high-quality assistants are always there to help – whether ladling or tray system.



Ladling system

After cooking or preparation, the food is kept in Gastronorm containers ready for transport. It is then served directly and

individually from food serving counters or trolleys.

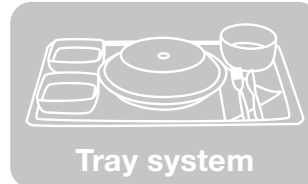

Tray system

Directly after cooking or preparation, food is pre-portioned on trays on the distribution conveyor. Once

plated, the food is transported in well-insulated, unheated or passively cooled tray transport trolleys and then served.



FROM THE KITCHEN TO THE DINERS

First-class solutions for the entire process –
from goods receipt through to clearing.



Goods receipt

Storage

Preparation

Cooking



Multifunctional products such as GN containers and shelf trolleys are essential items in every kitchen.



Lading system

B.PRO COOK I-flex cooking station



B.PROTHERM food transport container



Serving and clearing trolley

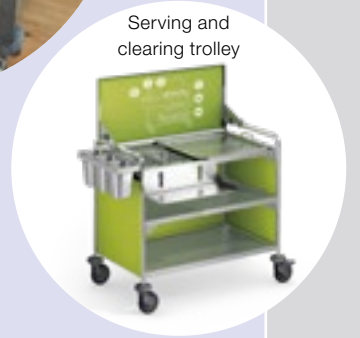

Food serving trolley

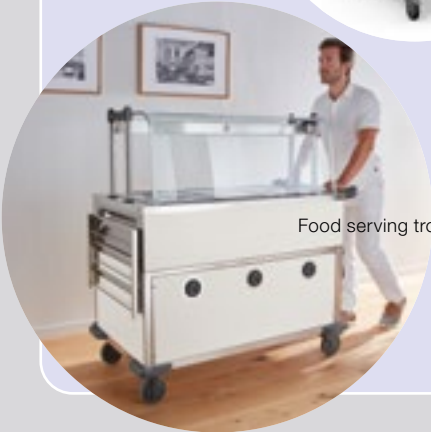

Food serving systems



Portioning

Transport

Serving

Clearing

Food serving trolley



Tray clearing trolley



Tray system



Tray transport trolleys are used for transporting, serving and clearing trays.



Lading system

LADLING SYSTEM

Food serving trolley for keeping dishes hot or cold: ideal for use in multi-purpose spaces.



In the smallest of spaces: the SAG 3 mobile food serving trolley with sliding lid as a practical storage surface. With the optional special insulation the compartments can be used as required – either with active heating or passive cooling with eutectic plates.

More sauce or an extra helping of rice? No problem! The lading system facilitates catering for individual dietary requirements or preferences. Depending on their care needs, residents can meet in the dining room. This maintains their independence and encourages communication, and new residents will find it easier to settle in.

Food serving trolleys are the ideal solution for mobile food serving in elderly residents' rooms, for residential groups and in multi-purpose spaces. When they have been loaded in the kitchen, they can be wheeled to the dining room, all the while keeping food at the correct temperature. This also means that individual mealtime schedules can be adhered to. Once the food serving trolleys are no longer needed, they are pushed back to the kitchen and the room can be used for something else.

With the optional coloured film coating, the closed food serving trolleys can be harmoniously coordinated to match their surroundings or, for instance, to comply with a specific colour concept in dementia care homes.

Temperature profile in closed food serving trolley (SAG) with special insulation

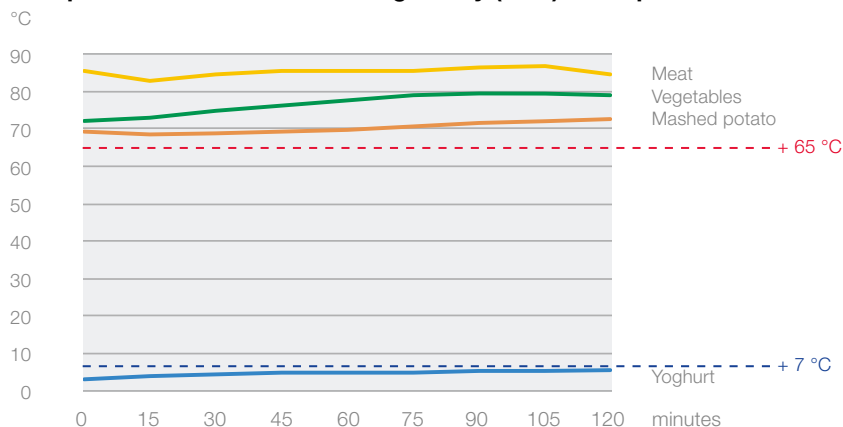

Food temperature measurement with temperature sensors. Heatable SAG with one heated and one passively cooled compartment.



Sturdy: SAG food serving trolley with coloured film coating and sneeze guard



Versatile: the B.PRO BASIC LINE food serving system



Ladling system

WELL-EQUIPPED

Food serving modules and mobile assistants for the dining room.

When it comes to busy dining rooms with a lot of visitors, B.PRO has a simple principle: perfect food presentation for every taste, ambience and budget.

The solution is called BASIC LINE. The serving system is available in the models Smart, Emotion and Design. It has impressively clear lines, a modular design and exceptional functionality that offers practically unrestricted freedom.

There are modules for every task: hot buffets, cold buffets, plain buffets, roll-in and servery counters, corner modules, soup stations etc.

For senior citizens with limited mobility, such as wheelchair users, various modules are available with a lower body height. This means that even residents with restricted mobility can serve themselves as they please.



Durable and sturdy: B.PRO serving trolleys are mobile assistants for a wide range of situations, for example when setting tables in the dining room. With colour-coordinated panelling and doors to match BASIC LINE, they look great in all interiors.

B.PRO colours

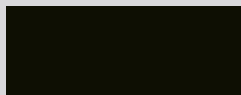

Graphite black



Broom yellow



Candy red

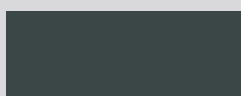

Traffic grey B



Merlot red



Neomint



Stone grey



Petrol green



Apple green



Signal white



Sea blue



Lime

LET'S COOK!

B.PRO COOK I-flex for a fresh helping of variety –
right before your eyes.

With food prepared individually and directly in front of the senior citizens, mealtimes become the highlight of the day – thanks to the ultra-flexible B.PRO COOK I-flex mobile cooking station.

It is ideal for switching quickly between various dishes, for instance at breakfast, throughout the day or as a source of motivation for cooking together.

Thanks to its compact size and low weight, caterers can easily transport and use it in various senior citizen facilities. B.PRO COOK I-flex is also suitable for special occasions, such as birthday celebrations.

The benefits:

- mobile cooking station with integrated extractor hood and induction hob.
- Small and light: available in various sizes and for different connection options, including 230 V connection.
- Intelligent, flexible use of the cooking zone for an array of preparation methods and cooking in portions.
- Efficient extraction with odour particle filtering and easy cleaning.





TRAY SYSTEM

Portioning on a conveyor: with Cook & Serve in the tray system, it's all about speed, smooth operation and excellent insulation properties.

Treating diners to fresh food means that after preparation dishes need to be served swiftly.

Keeping hot or cooling, portioning and transport – to preserve the quality and freshness of the dishes it is crucial to maintain the required temperature at every step of the distribution process.

Perfectly coordinated products and modern technology by B.PRO enable an optimal workflow.

We offer solutions for different production processes and quantities and are happy to plan configurations based on your individual requirements.

Example for portioning: in this case the centre-piece is the food distribution conveyor for loading trays. Depending on requirements, the various dispensers, heatable food transport trolleys or cooling stations are brought into position.



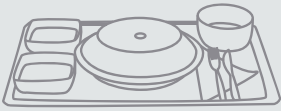

Tray system



← KS-UKI RWR-VP 163 cooling station for cooling pre-portioned salads and desserts.

For an extra helping of temperature safety

The powerful alternative for HACCP-compliant cooling of food in containers, such as cheese or cold cuts at room temperature: the KS-UK RWR 3-A cooling station with active convection cooling, combined with the RWR 3 KS or RWR 3-A KS shelf trolley. Ideal for early portioning of evening meals.

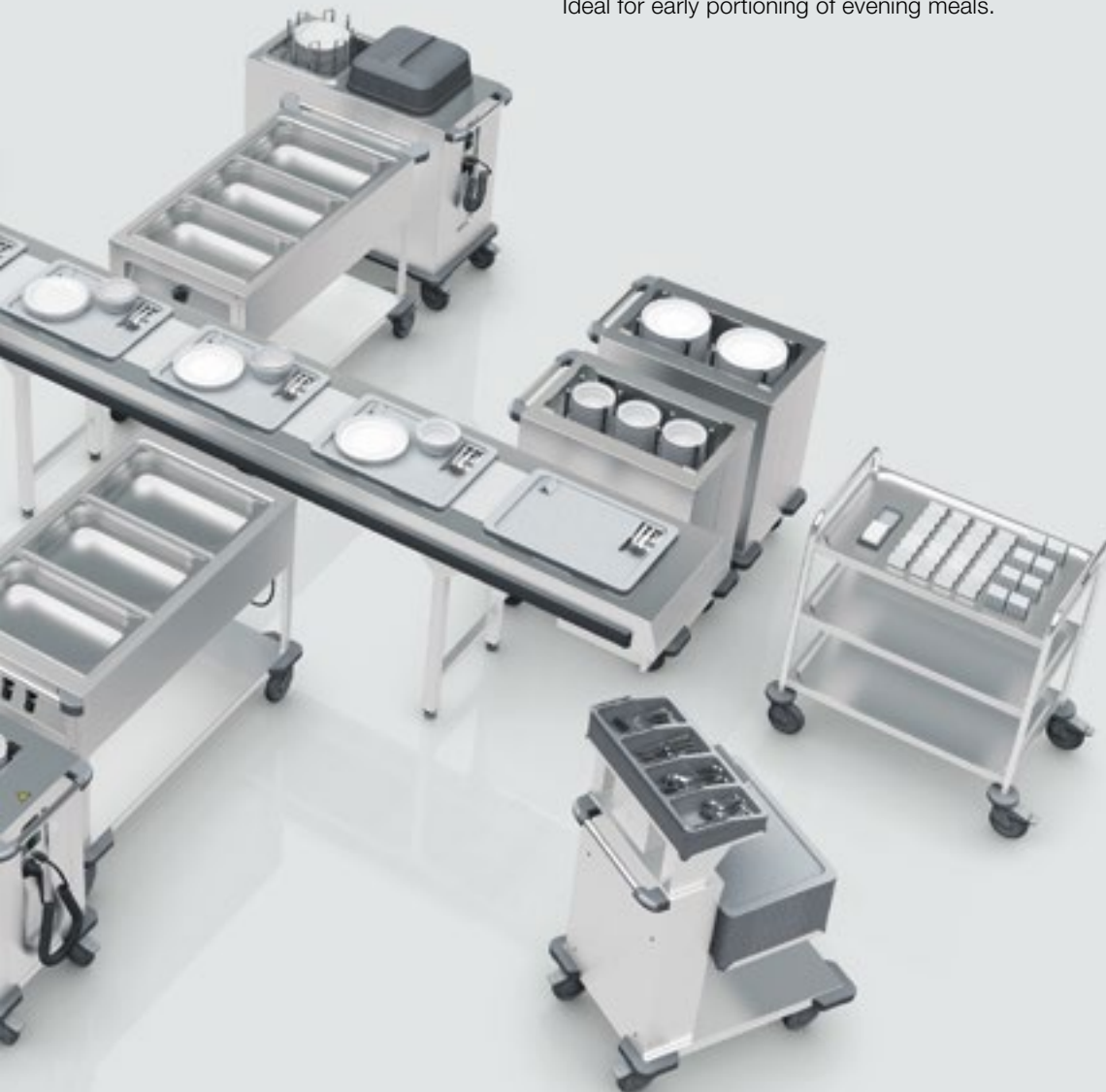



Tray system



TRAY TRANSPORT TROLLEYS

B.PRO tray transport trolleys for safe and hygienic food distribution in the tray system.

For food transport and serving, the B.PRO tray transport trolleys guarantee that portioned meals arrive at the table safely and properly insulated.

Seamlessly deep-drawn support ledges help you to load and clear trays quickly. Four extra-long push handles offer an ergonomic handle height for every member of the team, making the trolleys easier to push, pull and manoeuvre – regardless of body height and even with open doors.

The high-quality design ensures maximum hygiene with effortless cleaning.



Temperature profile in a passively cooled tray transport trolley (TTW-PK), equipped with eutectic plates (-12 °C)

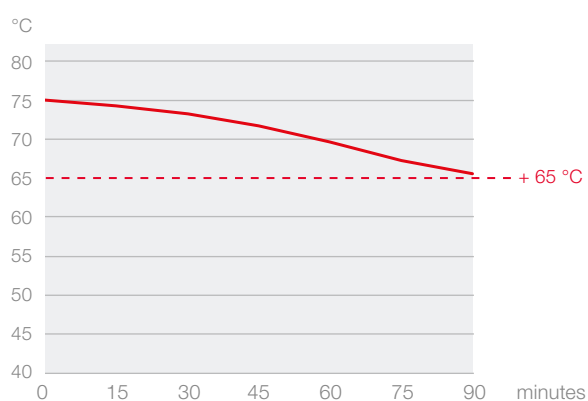

Hot food

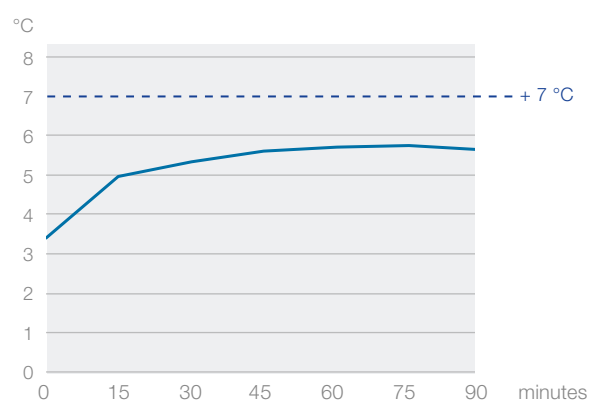

Cold food

Food temperature measurement with temperature sensors. Hot food temperature measured through use of insulated parts (heat-retaining lower base with wax core).

THE B.PRO GROUP

Our customers are as diverse and varied as our portfolio. To ensure we do our very best for every client, we concentrate our skills, abilities and capacities in two highly specialised business units: B.PRO Catering Solutions – Products and systems for professional commercial kitchens. ENOXX Engineering – Custom-made high-precision pieces using stainless steel, aluminium or synthetics for industry.

All business units of B.PRO hold DIN EN ISO9001:2015 certification, guaranteeing a high standard of reliability and customer orientation.

B.PRO GmbH
B.PRO Catering Solutions
P.O. Box 13 10
75033 Oberderdingen
Germany
Phone +49 7045 44-81900
catering.export@bpro-solutions.com
www.bpro-solutions.com

B.PRO
CATERING SOLUTIONS